

PLAN

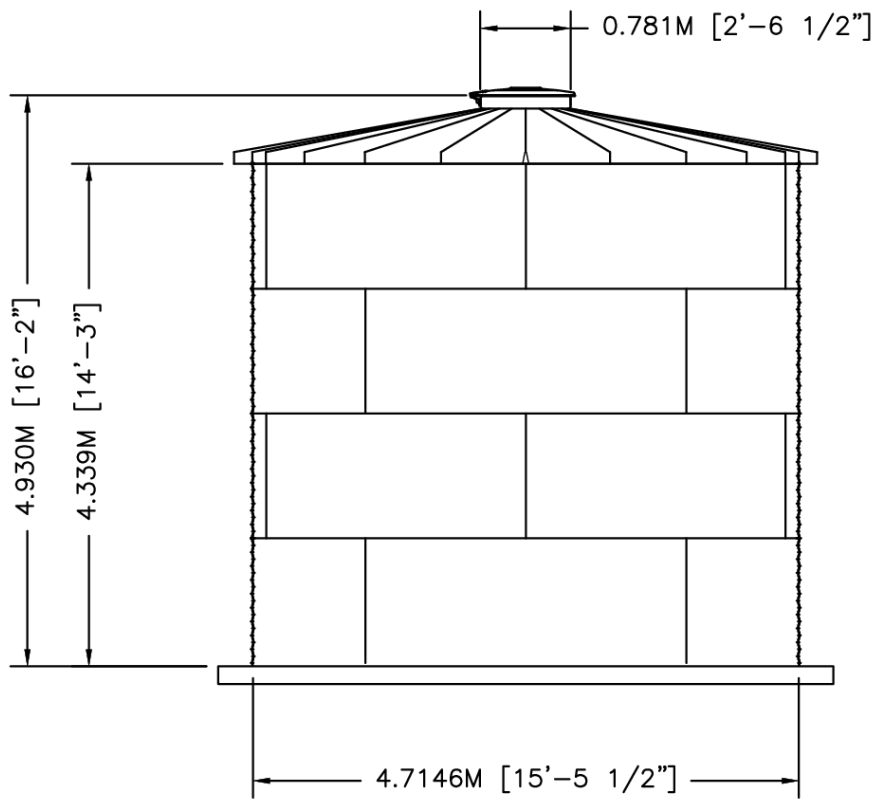

ELEVATION



	BY	DATE	TITLE	
DWN	XXX	XX/XX/XX	WTU05-04 30"PR 10DEG V-RIB	
CKD			NOMINAL CAPACITY - 73.607 M3 [19,445 GAL]	
ENG			DWG. NO. SCT1504-LVR WTU05-04	REV. NO.
			SIZE: A	SCALE: 3/16"=1'-0"
			SHEET 1	OF 1